

RASA

Engineering Group

گروه مهندسی راسا

تولید و تامین تجهیزات اجرای سرامیک نما

سیستم پنهان







Rev.01

information

KEIL SYSTEM



تصویر محصول	کد پروفیل	شرح			وزن مخصوص
Picture	Profile Code	Description	$I_x \text{ cm}^4$	$I_y \text{ cm}^4$	Specific Weight
	CF 2062 - 20	ریل سیستم کیل	11.48	1.15	620
	CF 2062 - 30	ریل سیستم کیل	13.50	1.47	730
	CF 2461 - 38	ریل سیستم کیل	17.87	2.44	950
	CF 8080 - 84	ریل سیستم کیل	19.8	5.61	0.840
	CF 40101 - 21	سپری ساده	19.8	8.66	1.00
	CF 5070 - 20	سپری ساده	19.8	5.61	0.840

تصویر محصول	کد پروفیل	شرح	ابعاد	جنس	ضخامت
Picture	Profile Code	Description	Dimension	Material	THK mm
	AK 50	انکر کیل HS 5	5 mm	Stainless Steel	1.5~2
	AK 70	انکر کیل HS 7	7 mm	Stainless Steel	1.5~2
	AK 120	انکر کیل HS 12	12 mm	Stainless Steel	1.5~2
	AK 150	انکر کیل HS 15	15 mm	Stainless Steel	1.5~2
	P 610	پیچ آچارخور استیل	6x8 ~ 6x20	Stainless Steel	1.5~2
	V 615	واشر استیل	5 mm	Stainless Steel	1.5~2

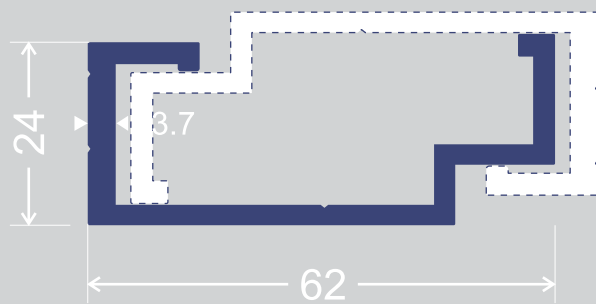

CK 2461 - 38

WEIGHT (kg)	950
LX (cm ⁴)	17.87
LY (cm ⁴)	2.44

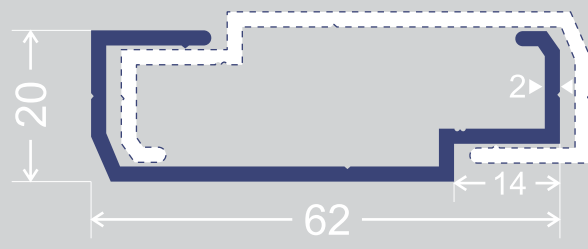

CK 2062 - 20

WEIGHT (kg)	620
LX (cm ⁴)	11.48
LY (cm ⁴)	1.15

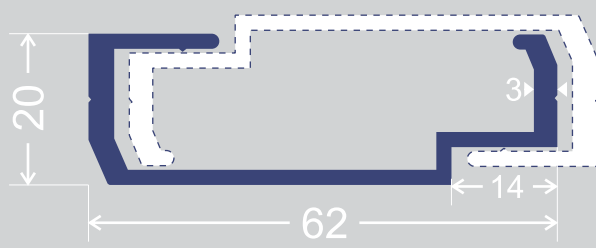

CK 2062 - 30

WEIGHT (kg)	730
LX (cm ⁴)	13.50
LY (cm ⁴)	1.47

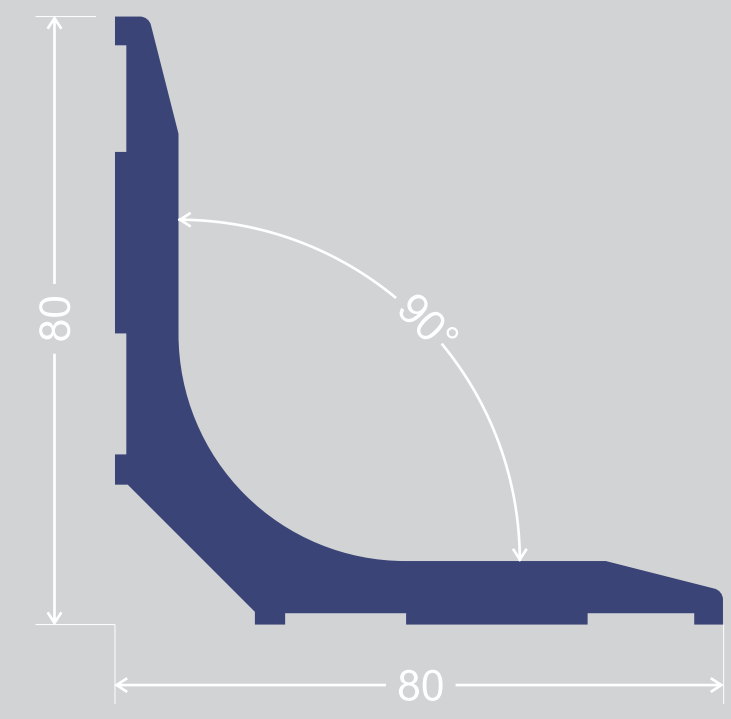

CF 8080 - 84

WEIGHT (kg)	0.840
LX (cm ⁴)	19.8
LY (cm ⁴)	5.61

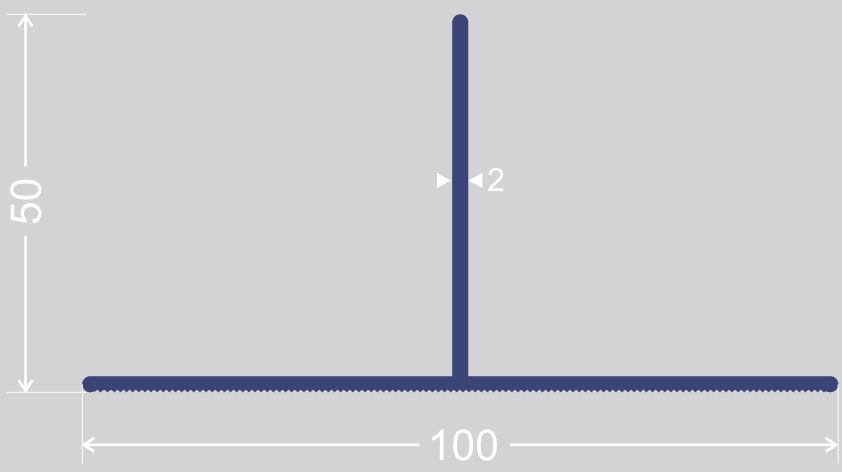

CS 40101 - 21

WEIGHT (kg)	1.00
LX (cm ⁴)	19.8
LY (cm ⁴)	8.66

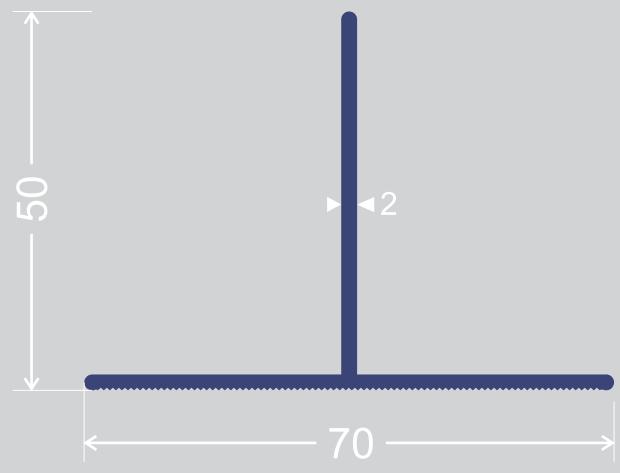

CS 5070 - 20

WEIGHT (kg)	0.840
LX (cm ⁴)	19.8
LY (cm ⁴)	5.61

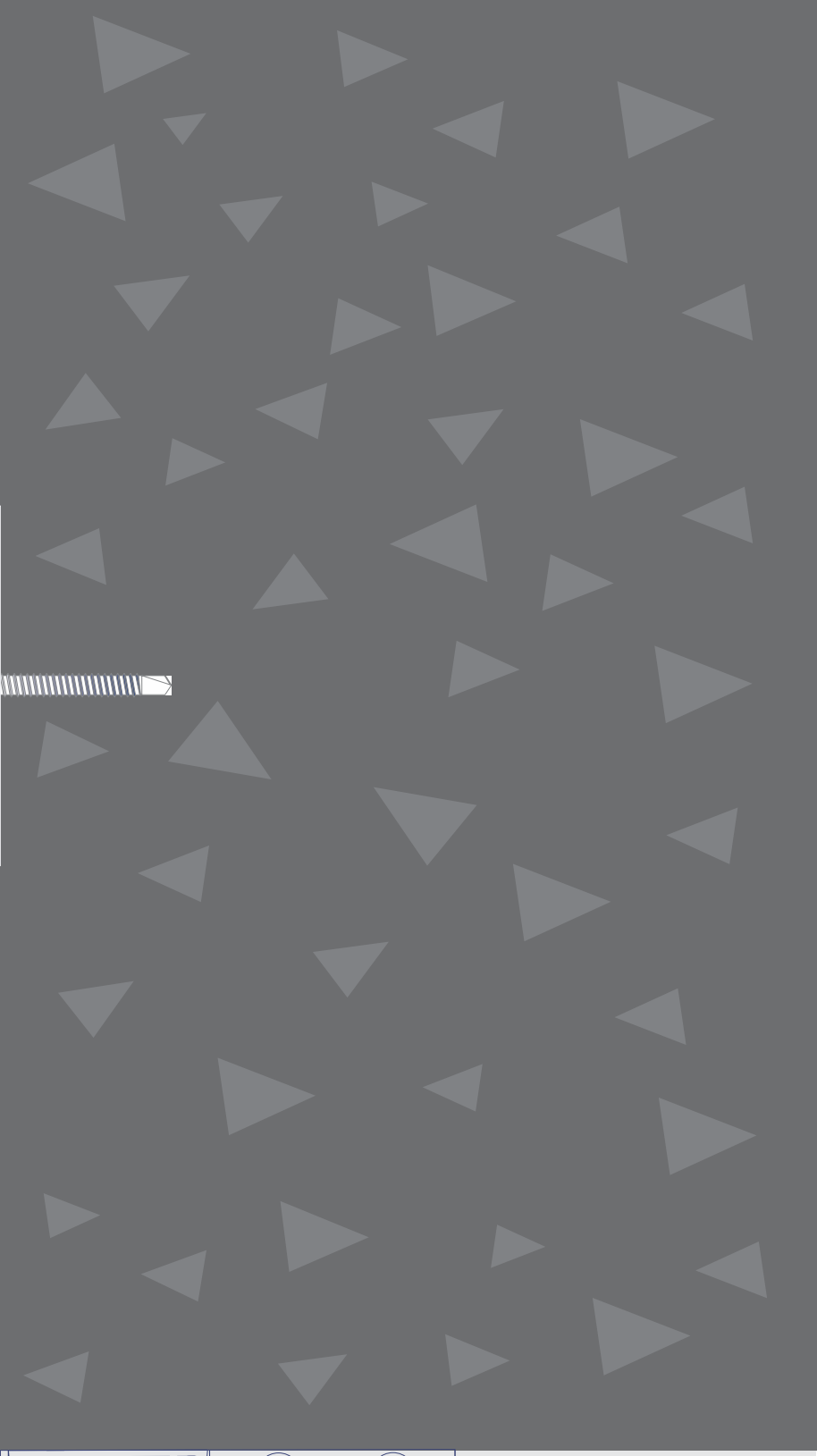
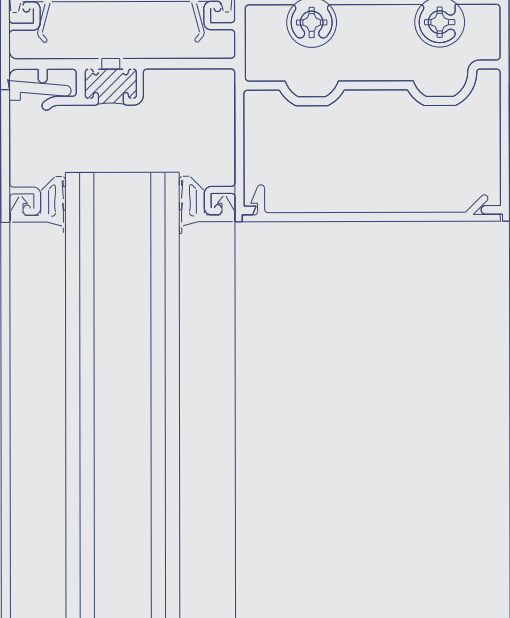
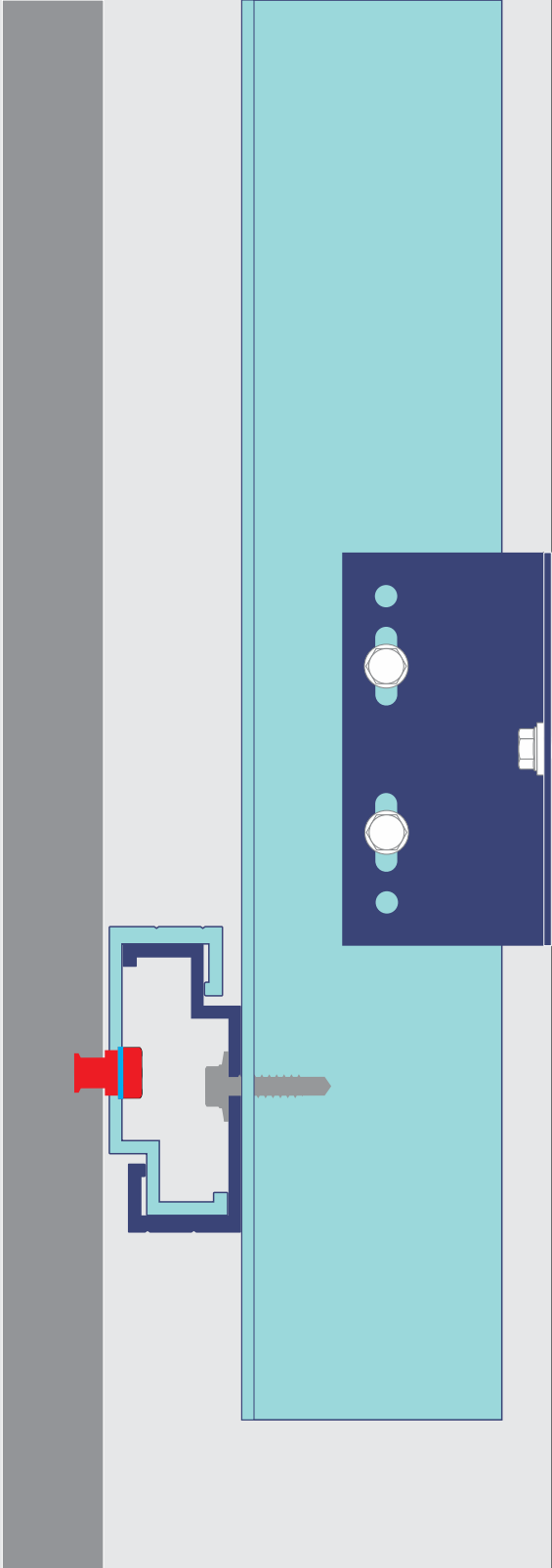

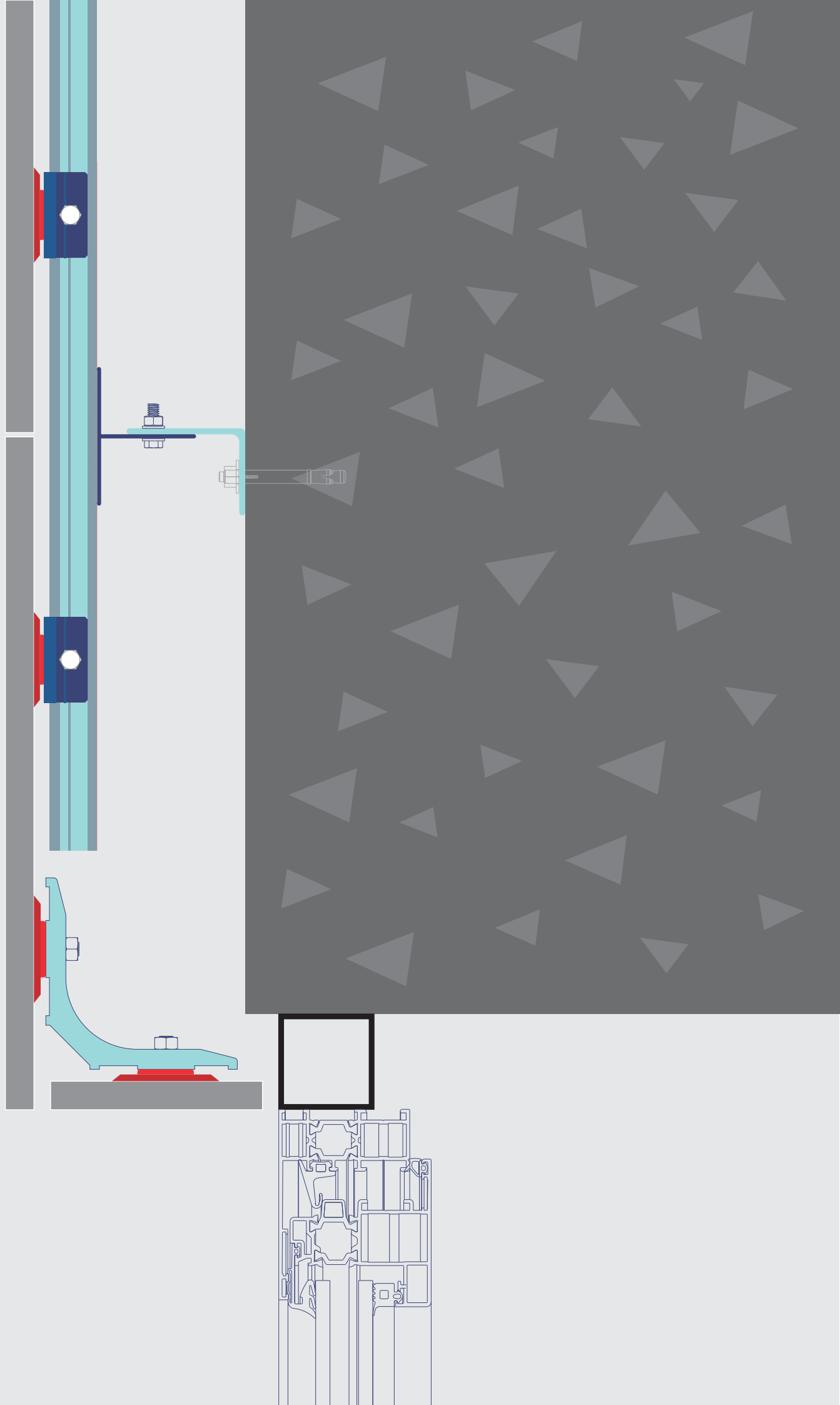

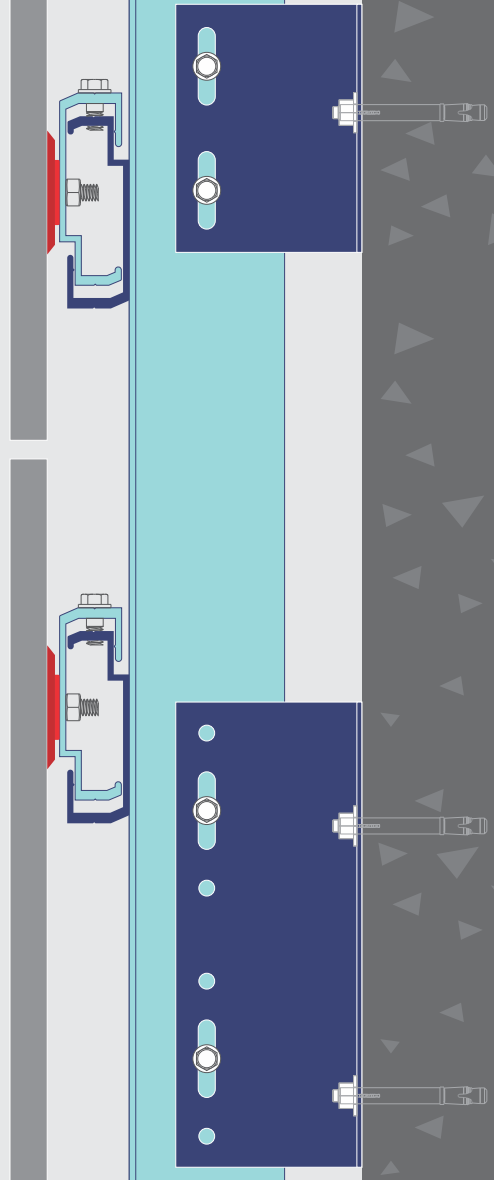
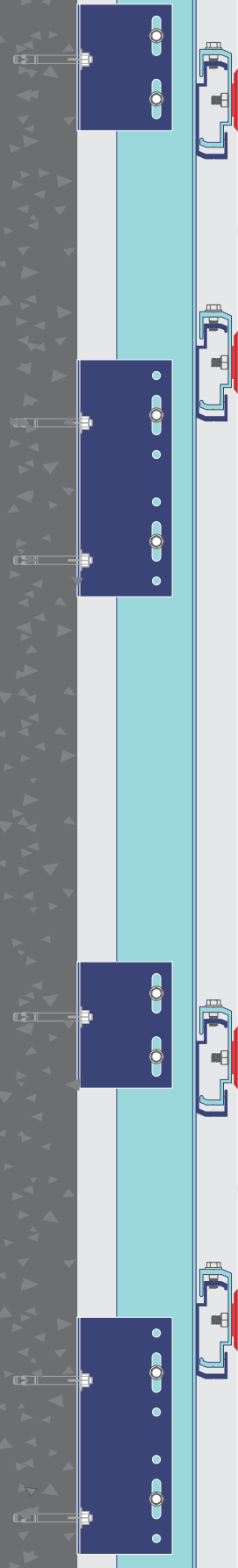





information

SHIARY SYSTEM



تصویر محصول	کد پروفیل	شرح			وزن مخصوص
Picture	Profile Code	Description	$I_x \text{ cm}^4$	$I_y \text{ cm}^4$	Specific Weight
	CS 1168 - 20	ریل سیستم شیاری	00	00	530
	CF 1249 - 15	قلاب سیستم شیاری	00	00	470
	CF 40101 - 21	سپری ساده	19.8	8.66	1.00
	CF 5070 - 20	سپری ساده	19.8	5.61	0.840

تصویر محصول	کد پروفیل	شرح	جنس	ضخامت
Picture	Profile Code	Description	Material	THK _{mm}
	GP 160	لاستیک سیستم شیاری	EPDM & PVC	00

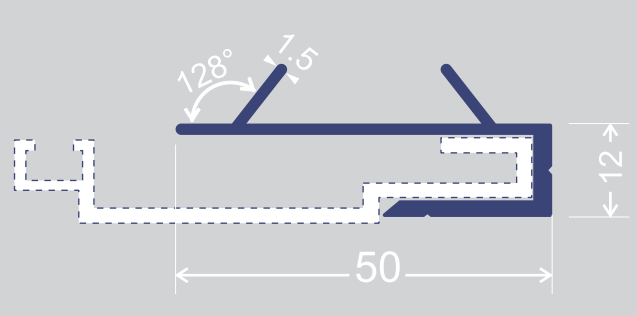
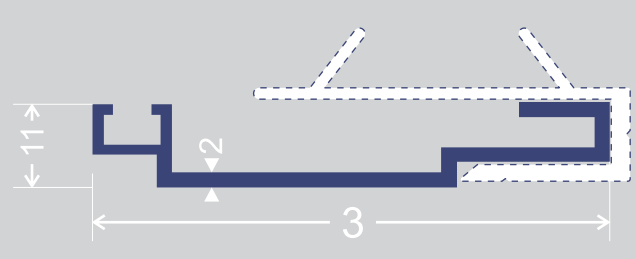
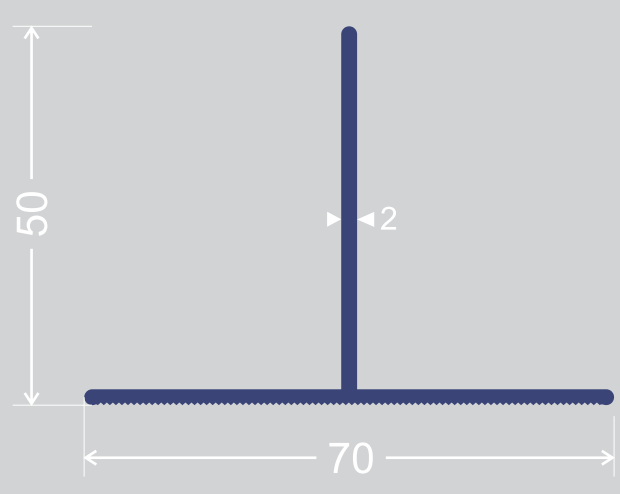
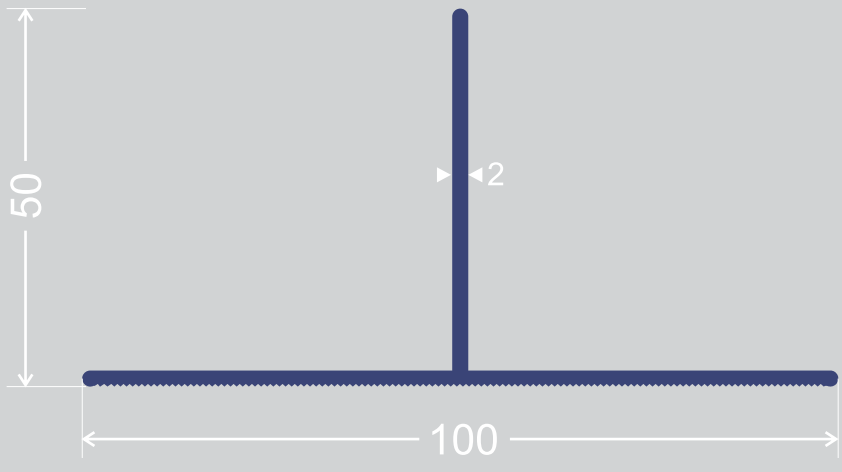

CS 5070 - 20

WEIGHT (kg)	0.840
LX (cm ⁴)	19.8
LY (cm ⁴)	5.61

CS 40101 - 21

WEIGHT (kg)	1.00
LX (cm ⁴)	19.8
LY (cm ⁴)	8.66

CS 1249 - 15

WEIGHT (kg)	620
LX (cm ⁴)	11.48
LY (cm ⁴)	1.15

CS 1168 - 20

WEIGHT (kg)	530
LX (cm ⁴)	00
LY (cm ⁴)	00

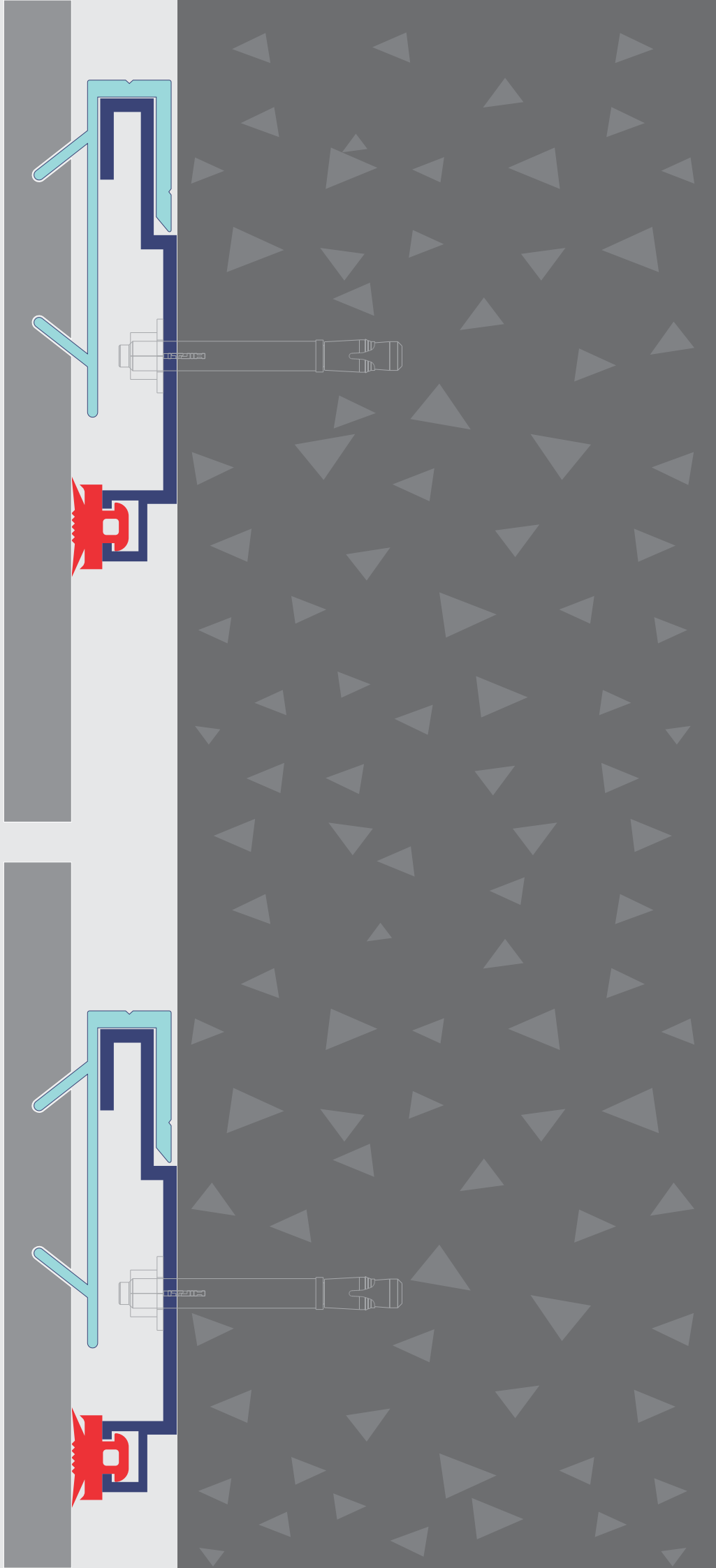

RASA

Engineering Group
گروه مهندسی راسا

+9821 - 82 80 92 80

+9821 - 26 74 91 39

Info@rasagp.com

www.rasagp.com

+98 - 912 830 7758

+98 21 - 91 69 31 85

تهران . خیابان پاسداران . دشتستان
پنجم . پلاک ۲۸ . واحد ۱۲

